

Securit®

Included

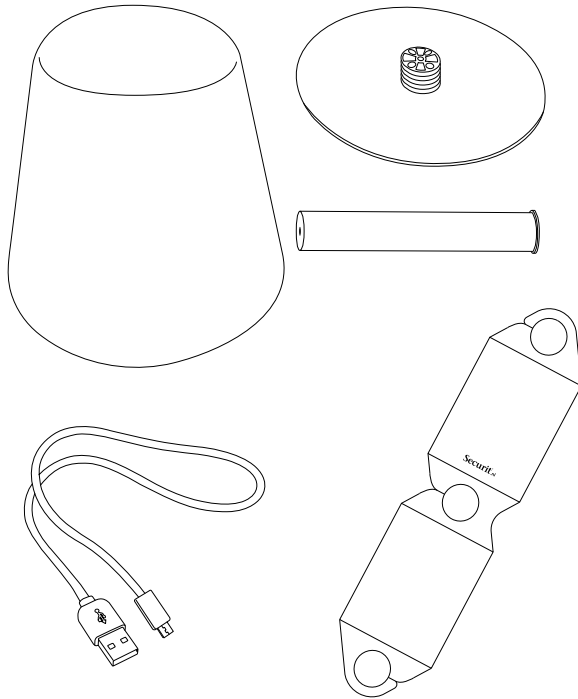

2

Optional:
Use a power
adapter to
charge. (not
included)

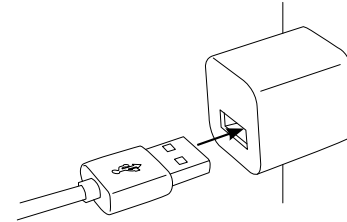

Optional:
Securit® Multi
charger
(MC-LD-MC10)

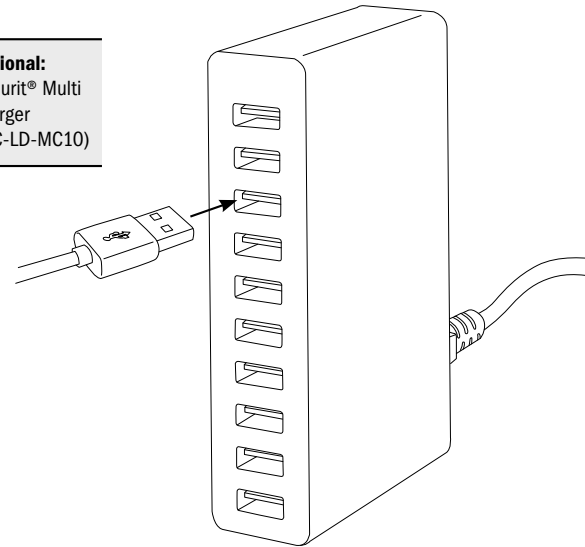

7

5. Charging

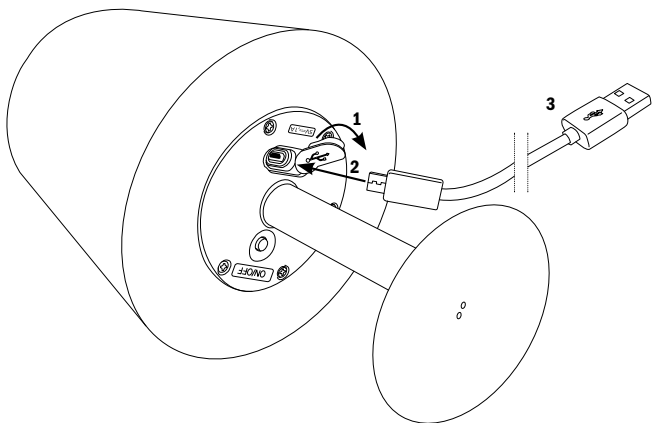

6 h
charge

1. Open the lid.
2. Plug in the USB cable.
3. Connect to USB power source.

6

1.

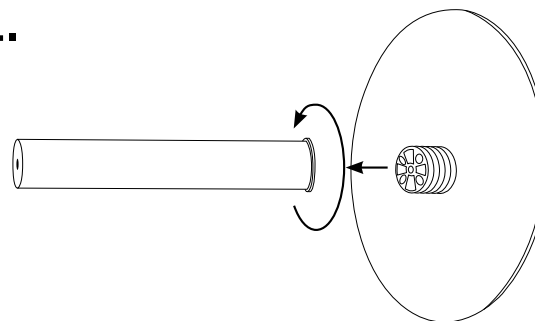

2.

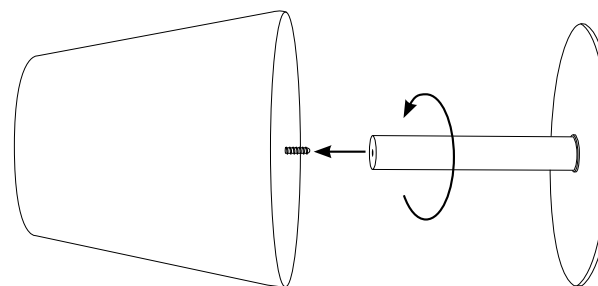

3

Securit®

3.

Important:

Charge your lamp
before first time
use (see step 5).

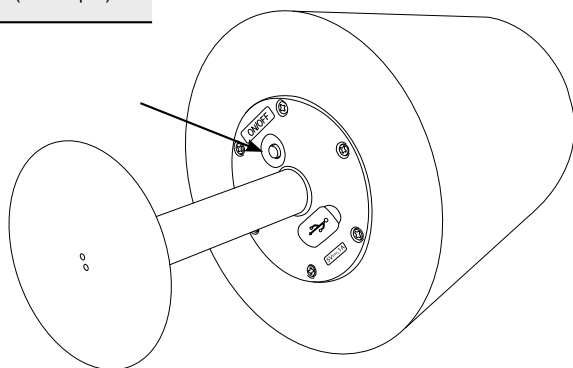



Push the ON/OFF button 1 second
to cycle through lighting modes (sleep,
low brightness, high brightness).

Push the ON/OFF button 2-3 seconds
to switch the light completely off or
back on.

4

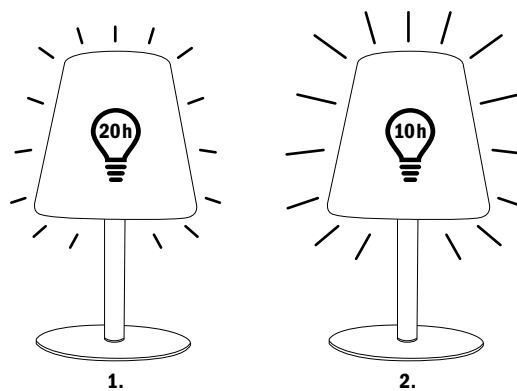
4.



1. Push the ON/OFF button once for  **low** brightness.
2. Push the ON/OFF button twice for  **high** brightness.

5